

# Security Command<sup>®</sup>

EXECUTIVE SERIES

-

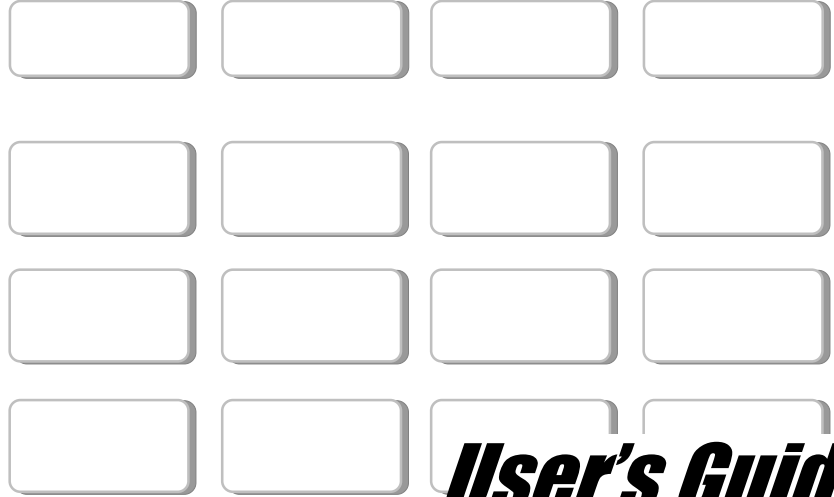

***User's Guide***

## Silencing an Alarm

### All/Perimeter and Home/Away Systems

1. While the alarm bell or siren is sounding, enter your user code. The keypad displays **DISARM SILENCE**.
2. Press the SELECT key under **SILENCE** to stop the bell or siren. This does NOT disarm the system.
3. If your system is programmed to send an Abort (alarm cancel) report to the central station, the keypad displays **ALARM CANCELLED**.

### Area Systems

1. While the alarm bell or siren is sounding, enter your user code. The system silences the alarm bell or siren.
2. If your system is programmed to send an Abort (alarm cancel) report to the central station, the keypad displays **ALARM CANCELLED**.

# Security Command® User's Guide

for XR6 and XR10 Command Processor™ Panels

## Table of Contents

### About your system

Emergency Evacuation Plans .....	ii
About Your Security System .....	1
The Security Command Keypad .....	2
Special Security Command Messages .....	3
Special Security Command Tones .....	3
Understanding Security System Terms .....	4
How your System Operates .....	6

### Arming and Disarming

All/Perimeter System Arming .....	7
All/Perimeter System Disarming .....	8
Home/Away System Arming .....	9
Home/Away System Disarming .....	10

### User Menu Functions

Security Command User Menu .....	11
User Checkin .....	11
Sensor Reset .....	11
Outputs On Off .....	12

Bypass Zones .....	12
Zone Monitor .....	13
System Test .....	14
User Codes .....	14
Ambush Codes .....	15

### Display Events

Zone Bypass Event Displays .....	17
Zone Event Displays .....	18
Arming and Disarming Event Displays .....	18
User Code Change Event Displays .....	19
System Monitor Event Displays .....	19
User Checkin Event Displays .....	19

### How Your System is Setup

System Setup .....	20
Security Command Keypads .....	20
Outputs .....	20
User Codes .....	21

# Emergency Evacuation Plans

The National Fire Protection Association recommends that you establish an emergency evacuation plan to safeguard lives in the event of a fire or other emergency. Use the following steps as a guide.

## Draw a floorplan of your home or business

On a clean sheet of paper, draw the walls, windows, doors, and stairs. Also draw any obstacles that a person may encounter while exiting the building such as large furniture or appliances.

## Develop escape routes

Determine at least two routes the occupants in each room can take to safely escape. One route can be the most obvious such as the door. Another can be through a window that can be easily opened. If the window is high off the ground, an escape ladder should be provided.

Draw arrows on the floorplan to show escape routes from each room.

## Decide where to meet

Prearrange a meeting place outside and away from where emergency personnel are likely to be working. A neighbor's house or across the street in the front of the house are good locations. Always perform a head count to make sure all occupants safely exited. **NEVER ENTER A BURNING BUILDING.** If the head count shows one or more persons missing, give this information immediately to the authorities. Never enter a building to look for someone.

## Practice your escape plans

Devising an escape plan is only the beginning, before the plan can be effective everyone should practice the escape routes from each room.

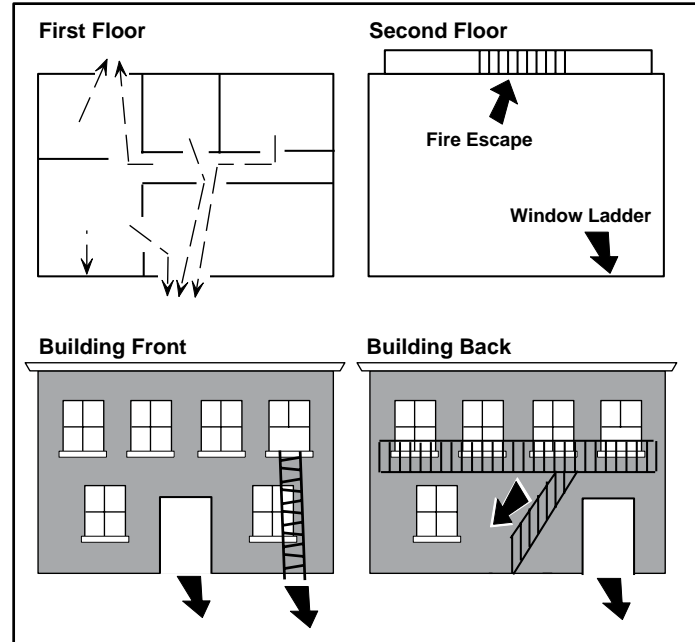

## Early detection

The best way to survive a fire or other emergency is to get out early. The installation of a fire alarm system, with smoke and carbon monoxide detectors in each room, can greatly decrease your risk of injury or loss.

# Introduction

## About Your Security System

Your Security Command system has been designed with your safety and comfort in mind. It uses the latest in computer technology to create the most user friendly security and fire system on the market today.

The system combines ease of use with a simple to understand Security Command keypad display to offer the full range of features requested by today's security system owners. Security Command can protect both the interior and perimeter of your home or business while you're away or just the perimeter when you're inside giving you a wall of security and peace of mind.

You can turn portions of your protection on or off at any time by pressing a few buttons. You can add, delete, and change personal security codes at any time or check the status of all protection devices in the system.

### Parts of the System

There are two main parts to the Security Command system, the Security Command keypad and the keypad User Menu.

#### Security Command keypad

This is the device we've placed at certain locations throughout the premises that allow you to turn the system's protection on and off using your personal security code.

#### Keypad User Menu

The keypad also supplies a User Menu containing all of the functions you need to fully operate your system.

## A Note About False Alarms

One of the most important concerns facing the security industry today is false alarms. The accidental dispatching of police and fire agencies places others in jeopardy by limiting the response capability of those emergency service units.

As part of our commitment to reducing false alarms, we'd like to encourage you to read this guide thoroughly. All the information contained here can help you quickly, and comfortably, learn the operation of the Security Command system. If you have any additional questions, or feel that you need more training, please don't hesitate to contact us.

## Test Your System Weekly

It is recommended that you test the burglary portion of your system at least once each week. Testing should involve an active test of all doors, windows, and motion detectors connected to your system. If your system also has fire protection, call the service department to find out how this portion of your system should be tested.

Refer to the System Test section of this guide for instructions on testing the burglary portion of your system.

# The Security Command Keypad

Your system may have one or more easy to use Security Command keypads (16 or 32 character) that allow you to properly operate the system. The illustration and descriptions below highlight some of the keypad features:

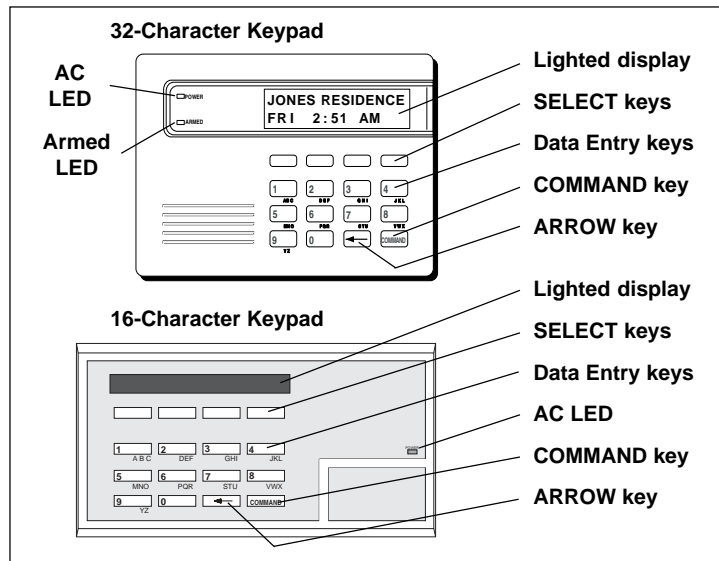

## The SELECT keys

There are four keys under the display called the SELECT keys. These keys are one of the features that make your system so easy to operate. They allow you to choose what to do by pressing the SELECT key under choices being shown in the display.

## Data Entry keys

These keys allow you to enter your user code when arming or disarming or enter other information into the system.

## The ARROW key

The ARROW key is used to go back through the keypad displays while operating your system. You can press the ARROW key to back up through the list of functions in the User Menu or to make a correction by erasing the last character you entered.

## The COMMAND key

The COMMAND key allows you to advance through the keypad displays or User Menu or complete a data entry function.

## AC LED

This LED remains on steady as long as your system is connected to its AC power supply. Should there be an interruption, the LED turns off and the system's backup battery maintains normal operation for a time allowing you to contact our service department.

## ARMED LED

This LED is ON steady anytime burglary protection is armed and OFF when ALL areas are disarmed.

## 32-Character Keypad User Options Menu

Press and hold the ARROW and COMMAND keys for about two seconds. The keypad display shows **SET BRIGHTNESS**. Use the left SELECT key to lower the display brightness. Use the right SELECT key to increase the display brightness. Press COMMAND.

At **SET TONE**, use the left SELECT key to lower the keypad tone. Use the right SELECT key to raise the keypad tone. Press COMMAND.

At **SET VOLUME LEVEL**, use the left SELECT key to lower the keypad volume. Use the right SELECT key to raise the keypad volume. Press the ARROW key to exit out of the User Options menu.

## Special Security Command Messages

As you use your system, you'll occasionally see a keypad display that asks you to enter a code or that describes a condition on the system. Below are some examples of the displays you'll see:

### ALARM

A 24 hour zone (for example, fire or panic) or an armed burglary zone has been faulted. Your system may sound bells or sirens.

### ALARM CANCELLED

An authorized user has cancelled an alarm condition by entering their security code.

### TROUBLE

There is a problem with a protection device or system component. This display is accompanied by a description of the problem.

### ENTER CODE

The system requires you to enter a personal code number. Code numbers can be required for turning your system on (arming), turning your system off (disarming), and many other system options.

As you enter your code number, the keypad display shows an asterisk (\*) in place of each digit pressed. This keeps others from seeing your code number on the display as it's entered.

### TRY AGAIN

The code number you've entered is not recognized by the system. Check the code number and try again.

### INVALID CODE

The code number you've entered a second time is considered invalid by the system.

### SYSTEM TROUBLE or SERVICE REQUIRED

There is an electronic failure in your system. Contact our service department as soon as possible.

## Special Security Command Tones

Your keypad also contains a small speaker that allows it to alert you to events as they occur on your system. Below are brief descriptions of the different tones you'll hear from the keypad:

**Fire alert:** Your keypad may sound a fire tone to alert persons in the vicinity to the alarm condition. This is in addition to the bell output from the alarm panel.

**Burglary alert:** Your keypad may sound a burglary tone to alert persons in the vicinity to the alarm condition. This is in addition to the bell output from the alarm panel.

**Key press tone:** A short beep as you press a key on the keypad.

**Prewarn tone:** A continuous pulsed tone that sounds when you open an entry delay door on a system that is armed (turned on) reminding you to disarm the burglary protection.

**Monitor tone:** A pulsed tone for one second, one pulse only that sounds whenever a door or window is opened while you're using the zone monitor function from the User Menu. See Zone Monitor.

**Trouble tone:** A steady tone indicating a trouble condition on your system. Press a SELECT key to silence the trouble tone.

# Understanding Security System Terms

Throughout this guide, and in some displays on your keypad, you'll see certain words or phrases that might be unfamiliar. Although every effort has been made to use terms that are commonly known, there are some for which there was no acceptable substitute.

Below are some terms you'll see here and on your keypad display:

## Arming

This is the term used for turning on the burglary protection in one or more areas of the system. Your system may require you to enter a code number. When armed, the system is able to sound alarm bells or sirens and, if monitored, send alarm reports to a central station when a burglary zone is faulted.

Fire, panic, and other 24 hour devices are always turned on and do not need to be armed.

## Disarming

This means turning off one or more areas of the system. When disarmed, the system does NOT sound alarms or send alarm reports to a central station when a burglary zone is faulted.

## Zone

A zone refers to a group of one or more protected openings or protection devices assigned the same zone number. Each door or window, motion detector, smoke detector, or other device has a zone number and a name.

Often, similar devices in the same general area will share the same zone. For example, the windows on the east side of the premises can all be grouped together in a zone named **E. WINDOWS**.

## Entry or Exit Zone

Almost all systems have one or more doors through which you can enter or exit the premises. These doors are programmed with a delay time to allow you to enter or exit while the system is armed without setting off the alarm.

When you arm the system, activity on all burglary zones is ignored until the programmed exit delay time expires. Once that time has expired and the system is fully armed, opening the door causes the panel to start the *entry* delay time. During the entry delay time, you must enter a valid code number to disarm the system or an alarm will occur.

## Instant Zone

Exterior windows and non entry doors, or interior protection devices, are typically not programmed with delay times. If these zones are faulted while the system is armed, an alarm occurs instantly.

## 24 Hour Zone

A 24 hour zone is never assigned to an area and is not turned on or off by arming or disarming your system. Some examples of 24 hour zones are: fire zones, panic zones, and temperature control zones.

## Areas

An area is made up of burglary zones that can be armed or disarmed together. The Perimeter area, for example, consists of all the doors and windows on the outside of the building. When you arm the Perimeter, these zones sound an alarm if faulted.



# Understanding Security System Terms

## Central Station Monitoring

Your system can also be programmed to automatically send alarm, trouble, and arming and disarming reports to a central station. Operators at the central station can in turn dispatch the appropriate authorities or contact you with the specific event information.

## Status

Status is a feature that automatically displays the armed or disarmed status of your system on the Security Command keypads. Alarm or trouble conditions on a zone or a system monitor such as AC or battery trouble can also be displayed. There are two types of status information available: **Armed Status** and **Status List**.

## Armed Status

With Armed Status, the keypad displays the current armed condition of areas within your security system.

The keypad displays	When
---------------------	------

<b>PERIMETER ON</b>	The perimeter zones are on
---------------------	----------------------------

<b>ALL SYSTEM ON</b>	All zones are on
----------------------	------------------

<b>PERIM/INT ON</b>	The perimeter and interior zones are on but the bedroom zone is off
---------------------	---

Also, for keypads that include an Armed LED, the Armed LED is ON steady anytime a burglary protection area is armed and OFF when ALL areas are disarmed.

## Status List

The keypad Status List displays any alarm or trouble condition on a zone and any trouble condition that occurs with the AC power or battery power. If more than one alarm or trouble condition occurs at the same time, the keypad sequences this information on its display.

If your system contains any Panic zones, these are *not* displayed on the keypad for security reasons.

If an alarm occurs on a non-fire 24 hour zone or a system monitor, it remains in the Status List until it restores. If one or more armed burglary zones trips, the last one to trip remains in the Status List. The burglary zone alarm remains in the Status List for several minutes or until it's cleared by disarming the system.

## Exit Error

This is an automatic function of the panel that prevents an alarm from occurring if an exit door doesn't close all the way after the system has been armed. Here's how it works:

You close all doors and windows, arm the system, and then leave by the front door. You close the door but it doesn't latch and opens slightly causing the front door zone to show as an open to the system. After the exit delay time expires the system attempts to arm the front door zone but recognizes the open condition and, instead of sending an alarm report to the central station, sends an Exit Error report and force arms the door. (If the door closes at a later time it will be included back into the system.) The system sounds the alarm sirens for 15 seconds to alert you of the condition and provide an opportunity for you to close the door.

The Exit Error feature allows the central station to acknowledge the arming error without dispatching the police on a false alarm.

## How your System Operates

Your system has been programmed to operate in one of two modes: All/Perimeter, or Home/Away.

- All/Perimeter - In this mode you select **All** to turn on the entire system or **Perimeter** to turn on just the exterior door and window protection when you're inside.
- Home/Away - In this mode you select **Away** to turn on the entire system or **Home** to turn on just the exterior door and window protection when you're inside. You can also have a third selection called **Sleep** that turns on interior protection devices that are not located near any bedrooms. The Sleep selection allows you to move freely around your bedrooms area without setting off the alarm.

Regardless of which mode has been programmed, much of the operation is similar. Throughout this guide, any differences between the systems are noted for your convenience.

### Arming Functions

After making your arming selection, the keypad displays any zones that are currently bypassed. These zones remain bypassed until the system is armed and then disarmed. Any 24 hour zones in a bad condition are also displayed.

Before arming, the system verifies that all doors, windows, and other protection devices to be armed are in normal condition. If everything is okay, the system arms. If there is a problem on one or more burglary zones the system cannot arm until the problem is corrected. If the problem is simply an open door or window, correct the problem and try arming again.

If the problem cannot be corrected, you can force arm or bypass the zone or wait until the zone can be repaired by a service technician. A **force armed** zone is ignored by the system until it restores to normal. A **bypassed** zone is ignored by the system during the entire armed period. A zone remains bypassed until the system is disarmed.

In some cases, you might see the keypad display **FRONT DOOR BAD \***. The asterisk next to **BAD** means that the zone is a priority zone, which cannot be bypassed. The problem on the zone must be corrected before the system can be armed.

**Armed Message:** After all bypassing is completed or zone faults corrected, the areas you selected are armed. The keypad briefly displays **ALL SYSTEM ON** if all areas in the system are arming and **PERIMETER ON** or **PERIM/INT ON** if only selected areas are arming. The keypad then displays the exit delay as it counts down. Zones are not armed until the exit delay time expires.

If your system uses a keyswitch to arm an area, the exit delay time is NOT shown on the keypad display.

**DIALING . . . Message:** If your system is monitored, it may be programmed to wait for the arming report to be sent to the central station before displaying the armed message. See Arming Report below. This is to verify your phone lines are working properly. While the system is waiting, the display reads **DIALING...** If the report is received, the keypad buzzes for one second and displays the armed message. If the report is not received, the keypad displays **LOCAL ALARM ONLY** before displaying the armed message.

**Arming Report:** Your system can be programmed to send arming or zone bypassing reports to a central station. This feature is optional and can be programmed for you at any time.

## All/Perimeter System Arming

**Area Assignment:** Your security system is divided into two separate areas. Motion detectors, inside doors, and other interior protection devices are assigned to the *Interior* area while windows and exterior doors are assigned to the *Perimeter* area.

**Perimeter or All:** When arming an All/Perimeter system, the keypad displays **PERIM ALL**. If you select **ALL**, you arm both the Perimeter and the Interior of the system. You'll want to arm both of these areas when leaving with nobody left inside. Selecting **PERIM** arms only the Perimeter of the system. Perimeter arming is for when you're staying inside but want the comfort of knowing the exterior doors and windows are armed. Perimeter arming allows you to move freely about inside without setting off any interior alarms.

### System Ready/System Not Ready Keypad Displays

When all zones in the system are in a normal condition, the keypad displays **SYSTEM READY**. If there are one or more zones that are not in a normal condition, the keypad displays **SYSTEM NOT READY**. Pressing any top row **SELECT** key during this display shows the zone name allowing you to investigate the problem.

### Bypass and Force arming

When one or more zones are in a *non-normal* condition, the keypad displays **OKAY BYPASS STOP**. Select **OKAY** to force arm the bad zones. Force armed zones that restore to normal while the system is armed are included back into the system. Select **BYPASS** to bypass the bad zones. Bypassed zones that restore to normal while the system is armed are NOT included back into the system. Use the bypass feature to remove a zone from the system that is temporarily out of service. This is a useful feature during remodeling when doors or windows are being removed.

## Arming an All/Perimeter System

1. Enter your user code. The keypad displays **PERIM ALL**.
2. Select **PERIM** to arm the Perimeter area only.
3. Select **ALL** to arm both the Perimeter and Interior areas.
4. The keypad displays any zones that have been bypassed prior to arming and 24 hour zones that are in a bad condition.
5. Bypass or force arm any bad zones if required. See below:
  - 5a. If a problem exists on a zone, the zone name and problem is displayed followed by **OKAY BYPASS STOP**.
  - 5b. Select **OKAY** to force arm the bad zone.
  - 5c. Select **YES** to bypass the bad zone.
  - 5d. Select **STOP** to stop the arming. Correct the problem on the zone and return to step 1.
6. The Security Command displays **PERIMETER ON** if only the perimeter is being armed and **ALL SYSTEM ON** if both the perimeter and interior are being armed.
7. The Security Command next displays **EXIT: ## INSTNT** and begins to count down the number of seconds remaining for you to exit. When the delay expires, all zones are armed.
8. You can select **INSTNT** while **EXIT: ## INSTNT** is displayed to immediately arm all exit zones and make them instant zones without exit or entry delays. The keypad displays **INSTANT**.
9. When the system is fully armed, the keypad displays **PERIMETER ON** for perimeter arming and **ALL SYSTEM ON** for perimeter and interior arming.

## All/Perimeter System Disarming

**Disarming:** While the system is armed, you can only enter the premises through an entry/exit delay door without causing an alarm. After opening the door, the Security Command keypad sounds a prewarn tone to remind you to disarm the system. You must disarm the system before the prewarn tone expires or an alarm on the door zone will occur.

During the prewarn tone, the keypad displays **ENTER CODE:**. Enter your security code to disarm the system.

**Alarm Display:** After disarming, the keypad displays any zones that tripped or any transmission problems that occurred during the armed period. All burglary zones are then disarmed and any bypassed zones are automatically reset.

**Disarmed Message:** The keypad displays **ALL SYSTEM OFF** after the system disarms.

**Central Station Report:** A report of the system disarming can be transmitted to the central station. This is optional and can be programmed for you at any time.

## Disarming an All/Perimeter System

1. During the entry delay time, the keypad displays **ENTER CODE:**. Enter your security code number.
2. The keypad then displays any zones that went into alarm or any communication problems that occurred during the armed period.
3. The keypad next displays **ALL SYSTEM OFF** to confirm the system is disarmed.

## Disarming During an Alarm

1. While the alarm bell or siren is sounding, enter your security code number. The keypad displays **DISARM SILENCE**.
2. Press the SELECT key under **DISARM** to disarm the system and silence the alarm.  
The keypad next displays **ALL SYSTEM OFF** to confirm the system is disarmed.
3. Press the SELECT key under **SILENCE** to stop the bell or siren but NOT disarm the system. Selecting **SILENCE** sends a Bell Silenced report to the central station.
4. If your system is programmed to send an Abort (alarm cancel) report to the central station, the keypad displays **ALARM CANCELLED**.

If you do not press any SELECT key while **DISARM SILENCE** is displayed, the system automatically selects **DISARM** and disarms the system.

# Home/Away System Arming

**Area Assignment:** Your security system is divided into two or three separate areas. Motion detectors, inside doors, and other interior devices are assigned to an *Interior* and possibly *Bedroom* area while windows and exterior doors, are assigned to a *Perimeter* area.

**Arming the system:** When arming a Home/Away system, the keypad displays **HOME AWAY** or **HOME SLEEP AWAY**. If you select **AWAY**, you arm all areas of the system. You'll want to arm all areas when leaving with nobody staying inside. Selecting **HOME** arms only the Perimeter of the system. Perimeter arming is for when you're staying inside but want the exterior doors and windows armed. Selecting **SLEEP** arms the Perimeter and Interior devices but leaves devices near bedrooms or other nighttime areas off.

## System Ready/System Not Ready Keypad Displays

When all zones in the system are in a normal condition, the keypad displays **SYSTEM READY**. If one or more zones are not in a normal condition, the keypad displays **SYSTEM NOT READY**. Press any top row SELECT key during this display to show the bad zone name.

**Instant:** During the exit delay time, you can cancel the exit and entry delays and cause all zones to be instant zones. Just press the far right SELECT key under INSTNT while the exit delay is displayed. This immediately arms the exit zones without entry delays and an alarm will occur should an entry door be opened.

## Arming a Home/Away System

1. Enter your user code. The keypad displays **HOME AWAY** or **HOME SLEEP AWAY** (you may have three areas).
2. Select **HOME** to arm the Perimeter only.

3. Select **SLEEP** to arm the Perimeter and Interior.
4. Select **AWAY** to arm the Perimeter, Interior, and Bedroom.
5. The keypad displays zones that have been bypassed prior to arming and 24 hour zones that are in a bad condition.
6. Bypass or force arm any bad zones if required. See below:
  - 6a. If a problem exists on a zone, the zone name and problem is displayed followed by **OKAY BYPASS STOP**.
  - 6b. Select **OKAY** to force arm the bad zone. Force armed zones that restore to normal while the system is armed are included back into the system.
  - 6c. Select **YES** to bypass the bad zone. Bypassed zones that restore to normal while the system is armed are NOT included back into the system.
  - 6d. Select **STOP** to stop the arming. Correct the problem on the zone and return to step 1.
7. The Security Command displays **PERIMETER ON** if you selected **HOME**, **PERIM/INT ON** if you selected **SLEEP**, and **ALL SYSTEM ON** if you selected **AWAY**.
8. The Security Command next displays **EXIT: ## INSTNT** and begins to count down the number of seconds remaining for you to exit. When the delay expires, all zones are armed.
9. You can select **INSTNT** while **EXIT: ## INSTNT** is displayed to immediately arm all zones and make them instant. The keypad displays **INSTANT**.
10. When the system is fully armed, the keypad displays **PERIMETER ON** for Perimeter arming, **PERIM/INT ON** for Perimeter and Interior arming, and **ALL SYSTEM ON** for all areas armed.

## Home/Away System Disarming

**Disarming:** While the system is armed, you can only enter the premises through an entry/exit delay door without causing an alarm. After opening the door, the Security Command keypad sounds a prewarn tone to remind you to disarm the system. You must disarm the system before the prewarn tone expires or an alarm on the door zone will occur.

During the prewarn tone, the keypad displays **ENTER CODE:**. Enter your code to disarm the system.

**Alarm Display:** After disarming, the keypad displays any zones that tripped or any transmission problems that occurred during the armed period. All burglary zones are then disarmed and any bypassed zones are automatically reset.

**Disarmed Message:** The keypad displays **ALL SYSTEM OFF** after the system disarms.

**Central Station Report:** A report of the system disarming can be transmitted to the central station. This is optional and can be programmed for you at any time.

### Easy Exit™ Feature

While the system is armed, you can also just press the COMMAND and then the 9 key to restart the exit delays to allow you to exit the premises without disarming the system. After the exit delay time expires, the system rearms automatically. This feature allows you to get the paper, let your pet out, or leave for work without having to disarm and then rearm the system.

## Disarming a Home/Away System

1. During the entry delay, the keypad displays **ENTER CODE:**. Enter your 4 digit security code.
2. The keypad then displays any alarms or communication problems that occurred during the armed period.
3. The keypad next displays **ALL SYSTEM OFF** to confirm the system is disarmed.

## Disarming During an Alarm

1. While the alarm bell or siren is sounding, enter your 4 digit security code. The keypad displays **DISARM SILENCE**.
2. Press the SELECT key under **DISARM** to disarm the system and silence the alarm.  
The keypad next displays **ALL SYSTEM OFF** to confirm the system is disarmed.
3. Press the SELECT key under **SILENCE** to stop the bell or siren but NOT disarm the system.
4. If your system is programmed to send an Abort (alarm cancel) report to the central station, the keypad displays **ALARM CANCELLED**.

If you do not press any SELECT key while **DISARM SILENCE** is displayed, the system automatically selects **DISARM** and disarms the system.

## Security Command User Menu

Many of the features of your system have been put into a User Menu you can access from any Security Command keypad. The menu requires you to enter your user code and then only shows those functions to which you have access.

### To access the User Menu:

1. Press the COMMAND key until **MENU? NO YES** displays.
2. Select **YES**. The keypad displays **ENTER CODE: –**. Enter your user code. You can now scroll down through the list of system features available to your authority level. The following pages detail each User Menu item and instruct you on when and how to use them properly. The **User Code Level** reflects the authority level required.

## User Checkin

**User Code Level:** Master or Standard (Home/Away arming only)

**Function:** This feature allows you to monitor the arrival of employees or latchkey children by having a special **Checkin Report** sent to your numeric pager. Your system must be programmed for Home/Away arming and the Pager Direct™ option.

### Sending a Checkin Report:

1. After disarming the system, access the User Menu. (Or press the COMMAND + 7 keys and enter your code to send a Checkin Report. This feature works on 32-character keypads only.)
2. At the **USER CHECKIN?** display, press any SELECT key. The keypad displays **USER CHECKIN: 11** ( 11 = user number).
3. The panel sends the Checkin Report containing your account number and user number to the pager.

## Sensor Reset

**User Code Level:** Master or Standard

**Function:** Resets smoke or glassbreak detectors. Also clears Fire/Supervisory alarm and trouble keypad displays.

Sensor Reset is used to reset smoke and glassbreak detectors after they have been tripped. Once these detectors have tripped, they must be reset before they can detect any additional alarm conditions. When Sensor Reset is selected, power to the detectors is temporarily removed by the system allowing them to reset.

Make sure all smoke is cleared from around the area of the smoke detectors before performing a Sensor Reset to prevent the alarm from occurring again.

### Resetting the Sensors

1. Access the User Menu.
2. When **SENSOR RESET?** is displayed, press any SELECT key. The keypad displays **SENSORS OFF** for five seconds followed by **SENSORS ON**.
3. The keypad returns to the status display.

### Enter your security code to reset sensors

While your system is disarmed, you can just enter your security code and press COMMAND to reset the sensors.

This also activates the door strike if your system has an Easy Entry™ keypad.

## Outputs On Off

**User Code Level:** Master or Standard.

**Function:** Allows you to turn the system's outputs on and off.

This function is used to individually turn your system's relay outputs on and off. Your system may use these outputs to control interior and exterior lighting, or heating, air conditioning, or other appliances.

The names and numbers of the outputs on your system are located in the System Setup section at the back of this guide.

### Turning the Outputs On and Off

1. Access the User Menu.
2. Press the COMMAND key until **OUTPUTS ON/OFF?** displays.
3. Press any one of the SELECT keys.
4. The keypad displays **OUTPUT: - ON OFF**.
5. Enter the output number you want to turn on or off. The output number will appear in the display.
6. With the output number displayed, press the SELECT key under **ON** or **OFF**. The output is then turned on or off, depending on your selection, and remains in that state until you change it.
7. The system automatically removes the output number and a new output number can be entered. Refer back to step 5.

To exit the Output menu option, press the ARROW key until you've returned to the keypad's Status List.

## Bypass Zones

**User Code Level:** Master or Standard.

**Function:** Allows you to bypass a zone prior to arming the system.

Bypassing is usually done when a zone cannot be restored to normal and you want to arm the system. Once bypassed, the system will not respond to any activity on the zone.

A zone can be bypassed only while it's disarmed. Since Fire, Panic, Emergency, and Supervisory zones are always armed, they can never be bypassed.

The Bypass Zones function can also be used to restore a bypassed zone back into the system. This can only be done while the zone is disarmed.

When Bypass Zones is selected, a report of the bypassing can be sent to your central station. This is optional and can be programmed for you at any time.

### Using the Bypass Zones Function

1. Access the User Menu.
2. Press the COMMAND key until **BYPASS ZONES?** displays.
3. Press any one of the SELECT keys. The keypad displays **ZONE: - RST BYPS**.
4. To reset a zone, enter the zone number and press the SELECT key under **RST**.
5. To Bypass a zone, enter the zone number and press the SELECT key under **BYPS**.



# Zone Monitor

**User Code Level:** Master and Standard.

**Function:** Allows the system to monitor selected disarmed zones (doors, windows, or motion detectors) and sound a tone at the keypad as well as display their name on the keypad display as they're faulted.

This is an ideal feature for monitoring door zones to tell when someone comes in or goes out.

You can place any combination of disarmed zones in Zone Monitor but only the most recent zone faulted is displayed. The displayed zone name clears automatically after a short time or when the zone is armed.

Zone Monitor does not function while the system is armed but a zone placed into it will still be there when the system is disarmed.

**Using Zone Monitor as part of your weekly system test:** After using the System Test function (see page 14), place all perimeter and interior zones in Zone Monitor. Starting at the front door, go around and open and then close each door and window. You should hear the keypad beep each time. The keypad will also display the name of each zone as its device is opened.

Once all protected doors and windows have been tested, walk in front of each motion detector. The keypad should beep to confirm their operation. If at any time during your weekly testing a device does not cause the keypad to beep, call the service department for assistance.

## Using the Zone Monitor Function

1. Access the User Menu.
2. Press the COMMAND key until **ZONE MONITOR?** displays.
3. Press any one of the SELECT keys.  
The keypad displays **PERIM ALL NBR** .
4. Select **PERIM** to place all disarmed perimeter zones into Zone Monitor.
  - 4a. The keypad displays **PERIM? ADD RMV**.
  - 4b. Select **ADD** to add all perimeter zones to Zone Monitor.
  - 4c. Select **RMV** to remove all perimeter zones.
5. Select **ALL** to place all disarmed perimeter and interior zones into Zone Monitor.
  - 5a. The keypad displays **ALL? ADD RMV**.
  - 5b. Select **ADD** to add all disarmed zones to Zone Monitor.
  - 5c. Select **RMV** to remove all disarmed zones.
6. Select **NBR** to enter a specific zone number for zone monitor.
7. If **NBR** is selected, the keypad displays **ZONE : - ADD RMV**.
  - 7a. Enter any zone number and select **ADD** to add this zone.
  - 7b. Enter any zone number and select **RMV** to remove this zone.
8. The zone number automatically disappears and a new zone number can then be entered in step 7a.

## System Test

**User Code Level:** Master or Standard.

**Function:** System Test is used to test the battery, alarm bell or siren, and communication to a central station. The System Test function begins automatically as soon as you select it.

### Using the System Test Function

1. Access the User Menu.
  2. Press the COMMAND key until **SYSTEM TEST?** displays.
  3. Press any one of the SELECT keys. The system test begins automatically and the keypad displays:
    - 1) **BELL SOUNDING** during a two second bell test, then:
    - 2) **BATTERY - OKAY** or **BATTERY - TRBL** to indicate the condition of the battery, then:
  - \* 3) **TRANSMIT TEST** and **ATTEMPT NO : 1** during the transmit test, then:
  - 4) **TRANSMIT OKAY** or **TRANSMIT FAILED** to show the results of the transmit test, then:
  - 5) **TEST END** to indicate the System Test is complete.
  - 6) You can end the transmit test by pressing the ARROW key.
- \* The transmit test does not operate on local systems.

**Testing your system's burglary protection:** The System Test function should be part of your weekly testing and should be followed by placing the interior and perimeter burglary devices in Zone Monitor mode. This allows you to open and then close each protected door and window while listening for the keypad to beep confirming its operation. See Zone Monitor.

## User Codes

**User Code Level:** Master only.

**Function:** Allows you to add or delete a user from the system or change their security code or authority level.

There are three characteristics associated with each user code that define its capabilities within the system.



**User Number** - Your system supports twelve users. Each user is numbered from 1 to 12. This number identifies them to the system and is transmitted to the central station (if your system is monitored) when they arm or disarm the system.

**Security Code** - Users also have a 4-digit security code that they enter into the keypad when arming or disarming. This security code is kept secret from other users and is not transmitted to the central station when they arm or disarm.

A user enters *only* their security code when operating the system.

**Authority Level** - The user is also assigned a level of authority (Master or Standard) by the person administrating the system that determines the functions they can access.

The table to the right lists system functions users are allowed to access based on the authority level assigned to their codes at the time they're added to the system.

## User Codes continued

### User Code Authority Levels

System Options	Standard	Master
Sensor Reset	✓	✓
Outputs On/Off	✓	✓
Zone Monitor	✓	✓
System Test	✓	✓
Arm and Disarm	✓	✓
Display Events	✓	✓
User Codes		✓

### Adding User Code Numbers:

1. Access the User Menu.
2. Press the COMMAND key until **USER CODES?** displays.
3. Press any one of the SELECT keys. The keypad displays **ADD DEL CHG**.
4. Press the SELECT key under **ADD** to add a new user code. You must have a Master user code level to be able to add a user code to the system.
5. At the **USER NUMBER:** - prompt, enter a user number and press COMMAND. The display changes to **CODE NO:** .
6. Enter a user code number of 4 digits and press COMMAND. This is the number they will use each time they arm, disarm, or make changes to the system.

7. The display changes to **MASTER? NO YES**. Select **YES** to make this a Master code level with the authority to Add, Delete, and Change user code information.

Selecting **NO** displays **TEMP CODE NO YES**.

Master code levels do not display **TEMP CODE**.

- **NO** makes this a permanent user code with Standard authority.
  - **YES** makes this a temporary code with Standard authority that automatically expires in 7 days. Temporary codes are perfect for guests or service technicians. You can delete a Temporary user code at any time before the 7 days expires.
8. After making your selection, the display shows **USER # ADDED**.
  9. Press the ARROW key once to add another user or twice to exit from the User Menu.

## Ambush Codes

Your system may be programmed to allow user number 1 to be an Ambush code. This Ambush code functions identically to other codes with the exception that it sends a silent alarm to the central station. This silent alarm alerts the operator to a duress situation at the premises and prompts the immediate notification of the proper authorities.

Refer to the System Setup section of this guide to see if your system is programmed for Ambush. If so, do NOT program a code for user number 1 unless you intend to use the Ambush function.

## User Codes continued

### Deleting User Code Numbers:

1. Access the User Menu.
2. Press the COMMAND key until **USER CODES?** displays.
3. Press any one of the SELECT keys. The keypad displays **ADD DEL CHG**.
4. Press the SELECT key under **DEL** to delete a user code from the system. You must have a Master user code level to be able to delete a user code.
5. At the **USER NUMBER:** - prompt, enter the user number you want to delete and press COMMAND. The display changes to **USER # DELETED**.
6. The display then changes back to **USER NUMBER:** - for you to delete another user. Press the ARROW key twice to exit the User Menu.

### Changing User Code Numbers

1. Access the User Menu.
2. Press the COMMAND key until **USER CODES?** displays.
3. Press any one of the SELECT keys. The keypad displays **ADD DEL CHG**.
4. Press the SELECT key under **CHG** to change a user code number. You must have a Master user code level to be able to change a user code number.
5. At the **USER NUMBER:** - prompt, enter the user number you want to change (1 to 12) and press COMMAND.
6. The display changes to **CODE NO: \* \* \* \* \***.. Enter the new 4-digit user security code and press COMMAND. If the code you entered is already in use, or is a code used internally by the system, the keypad displays **ALREADY IN USE**. You must enter a different 4-digit user security code.
7. If you are changing a code other than your own, the keypad next displays **MASTER? NO YES**. Select **NO** if you want this user to have a Standard authority level. Select **YES** if you want this user to have a Master authority level.  
If Master, disregard item #8.
8. The keypad next displays **TEMP CODE NO YES**. Select **NO** if you want this security code to be permanent. Select **YES** if you want this security code to be automatically deleted from the system in 7 days.

**Important:** Changing a user's security code does not change their user number.

# Display Events

**User Code Level:** Master or Standard.

**Function:** Allows you to review up to 16 past events that occurred on your system from any keypad. Once 16 events are stored, any new event causes the oldest event to be cleared.

When accessed, the Display Events option displays events recorded automatically by the system in the order of their occurrence. You can view the events starting from the oldest to the most recent.

While in Display Events, you can use the COMMAND and ARROW keys to go forward or backward through the list of recorded events. There are five event types recorded by the system:

**Zone Events** - Records zone alarms, troubles, and restores to normal condition.

**Zone Bypass Events** - Records the bypassing of any zone. The zone number, zone name, and the user number of the person bypassing the zone is recorded.

**Arming and Disarming** - Records arming and disarming of the system by user number and the areas armed or disarmed.

**User Code Changes** - Records addition, deletion, and change of user codes. Also notes user number of person making the change.

**System Monitors** - Records any loss of AC power or low battery conditions on the system.

*User Menu*

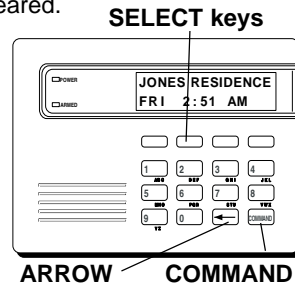

The event display you'll see at the keypad is slightly different for each event type.

## Using the Display Events Function

1. Access the User Menu.
2. Press the COMMAND key until **DISPLAY EVENTS?** displays. Press any SELECT key.
3. The keypad displays the oldest recorded event.

Use the COMMAND key to scroll down through the list of events. Use the ARROW key to scroll back up through the event displays. If you press the ARROW key when you first enter the Display Events, the keypad returns to the Status List.

## Zone Bypass Event Displays

This displays the bypassing of system zones.

Display	Description
	Zone 6 bypassed by user 12. Press the SELECT key under the zone number to display the custom zone name programmed into the system.

**Bypass Event Types** - There are 2 event types:

**BYP** - Bypass      **RST** - Restore

**Note:** You may sometimes see the user as **SWG**. This is short for the Swinger Bypass feature that allows the system to automatically bypass a zone that faults more than 3 times while the system is armed. Your system may or may not have this feature.

## Zone Event Displays

This section displays alarms, troubles, and other events that could occur on your system's protection zones.

Display	Description
	A burglary alarm occurred on zone 2. Press the SELECT key under the zone number to display the custom zone name programmed into the system.

**Zone Type** - There are 7 possible zone types you may see here.

**FIRE** - Fire      **PANC** - Panic      **BURG** - Burglary  
**EMRG** - Emergency      **SUPV** - Supervisory  
**AUX 1** - Auxiliary 1      **AUX 2** - Auxiliary 2

**Event Types** - There are 3 event type you may see here:

**ALR** - Alarm      **TBL** - Trouble      **RST** - Restore

## Arming and Disarming Event Displays

This displays any arming or disarming of system areas.

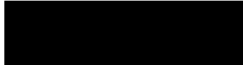
Display	Description
	All areas of the system were armed by user number 6.

**Arming Event Types** - There are 2 event type you may see here:

**ARM** - An authorized user armed the system  
**DIS** - An authorized user disarmed the system

**Area Descriptions** - There are 3 area names you may see here:

**ALL** - All areas in the system were armed or disarmed.  
**PERIM** - The Perimeter only was armed or disarmed.  
**SLEEP** - The Perimeter and Interior areas in a Home/Away system were armed or disarmed.

**User Numbers** - There are 12 user numbers available in your system. Each code has a user number (1 to 12) that is used by the system to identify the person using it. A user number of 0 (zero) is an arming or disarming that did not require a user code; for example: arming with a mechanical keyswitch.

## User Code Change Event Displays

This displays any addition, deletion, or change to a user code.

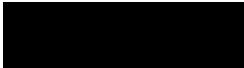
Display	Description
	User 9 added user 12 to the system.

**Code Event Types** - There are 3 event type you may see here:

**ADD** - User added      **DEL** - User deleted  
**CHG** - User code or authority level has been changed

The user number added, deleted, or changed is on the left. The user number of the person making the change is on the right.

## System Monitor Event Displays

This displays any loss of the system's AC power or battery.

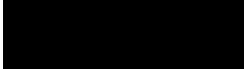
Display	Description
	An AC failure occurred on the system. Press the <i>right</i> Select key for the time.

**System Monitor Event Types** - There are 2 event types:

**TROUBLE**                      **RESTORE**

**System Monitor Event Names** - There are 2 system monitors:

**POWER** - Problem with the AC power to the panel  
**BATTERY** - Problem with a low battery. This could be due to the battery exceeding its life expectancy. Call the service department whenever you see a **BATTERY TROUBLE** display.

*User Menu*

## User Checkin Event Displays

This shows when a user selected the pager **CHECKIN** feature from the User Menu. See page 11 for more information.

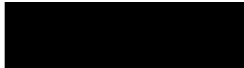
Display	Description
	User 11 selected the <b>CHECKIN</b> feature in the system's User Menu.

## Request for Service

**User Code Level:** Master or Standard.

**Function:** Allows you to send a Request for Service request to the central station when there is a problem on your system.

After the Display Events function in the keypad's User Menu, you'll see the **SERVICE REQUEST?** display if it has been programmed for your system. If this feature has been programmed, and you would like to send a Request for Service report to the central station, press any top row SELECT key while **SERVICE REQUEST?** is displayed. After the Request for Service report has been sent, the keypad displays **REQUEST MADE** for about four seconds. A service representative will then call you and arrange for a service technician to be dispatched.

If there is a problem with the telephone line connected to the system, you must contact our service department directly for assistance.

## System Setup

We've provided this System Setup section to allow you to track the current and future status of the programmable options on your Security Command system. If you make changes to the system, you should update the information contained on these pages.

### Your system is monitored by a central station.

Yes       No

C/S Name: \_\_\_\_\_

Address: \_\_\_\_\_

City/State: \_\_\_\_\_

Emergency Phone: \_\_\_\_\_

Service Phone: \_\_\_\_\_

Service Manager: \_\_\_\_\_

### Your system sends Opening and Closing reports.

Yes       No

### Your system sends Zone Bypass reports.

Yes       No

### Your system sends Ambush reports.

Yes       No

## Security Command keypads

Address	Locations
1	_____
2	_____
3	_____
4	_____

## Outputs

Your system has 4 outputs that are used to control various functions within the building or around its perimeter. Below is a list of these outputs and the devices they control.

Output #	What it controls
1	_____
2	_____
3	_____
4	_____

Enter the Output number above when using the Outputs On Off User Menu option to manually toggle the outputs.



## User Codes

Your system provides you with twelve user codes you can program for individual users. As you add new users or change current user's codes, you can keep track of their name, user number, and authority level here in this section.

User	User Name	Level
1		Master - Standard
2		Master - Standard
3		Master - Standard
4		Master - Standard
5		Master - Standard
6		Master - Standard
7		Master - Standard
8		Master - Standard
9		Master - Standard
10		Master - Standard
11		Master - Standard
12		Master - Standard

## Pager Direct™ User's Guide

Pager Direct uses the reporting capability of your security system to dial your pager number and send reports in much the same way as someone sending you a pager message would do. You can receive reports of alarms, troubles, or armings and disarmings of the system and know at a glance the status of your system.

**Area Names**

List your system's area names and numbers below:

Area	Name	Area	Name
1 _____		3 _____	
2 _____		4 _____	

Service Department Phone: \_\_\_\_\_

Emergency Phone: \_\_\_\_\_

Central Station Phone: \_\_\_\_\_

**Pager Direct™**



Security Command Numeric Paging

Fold

Cut along dotted lines

## Numeric Pager Display

00128-301234



### Account Number

This number has been programmed into your Security Command system as an identifier. Whenever the system sends a message to your pager, it will always send the account number first to identify itself.

### Message ID

This is always a single digit, 1 to 6, that describes the message sent.

1 = Zone Alarm    3 = Area(s) Arming  
2 = Zone Trouble    4 = Area(s) Disarming    6 = User Checkin

### Zone, Area, or User Number

If this message is for a zone, the 1 to 2 digit zone number is displayed.

If this message is for areas that are being armed or disarmed, the area numbers are shown in sequential order. Example: 1 2 4.

## Security Command Numeric Paging

**Notes:**

## **Digital Monitoring Products**

---

2841 E. Industrial Drive Springfield, MO 65802-6310 800-641-4282

LT-0226 (4/99)